

Roadranger®

Dana® Spicer® Brakes

Automatic Slack Adjusters
All Models



One Great Drivetrain from Two Great Companies

Illustrated Parts List BRIP-0075 December 1995

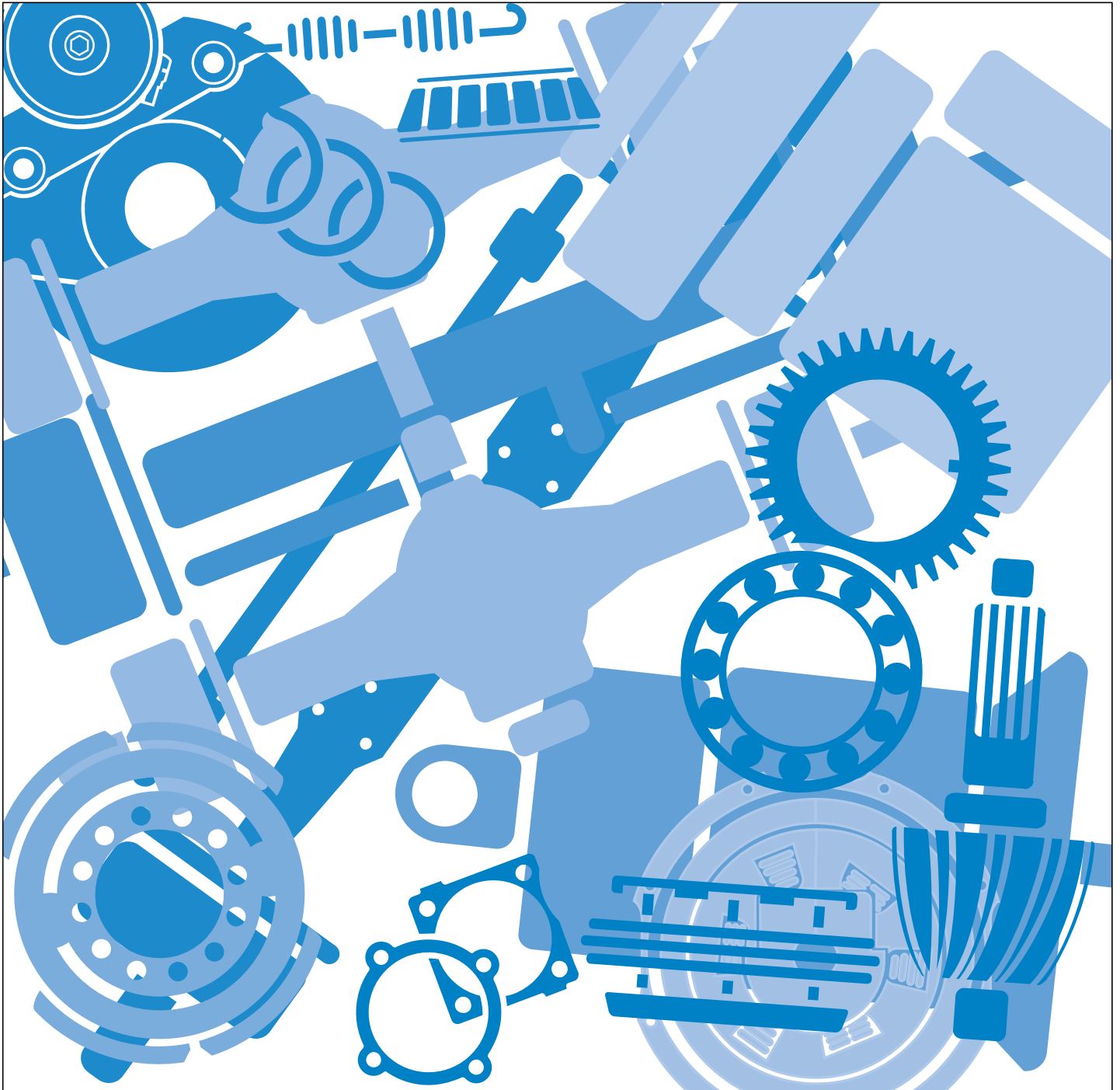

For the most current information, visit the Roadranger web site at www.roadranger.com

Eaton Corporation, Axle & Brake Division presents this Parts Book as an aid in the identification and procurement of replacement parts for Eaton truck components. The information included covers Eaton automatic slack adjusters, an application guide for choosing the correct service part number and a helpful interchange section.

Genuine Eaton Parts.

When you buy genuine Eaton replacement parts, you receive the same high quality and exacting tolerances you find in the original axle components.

Only genuine Eaton parts have the latest Eaton engineering improvements and assure equal or better performance than the original parts.

Insist on Eaton quality. Use genuine Eaton replacements parts.

How to use this Parts Book

1. Refer to "How to select slack adjusters" on page 2 for reference on how to determine correct slack adjusters applications.
2. Refer to the table of contents for the correct page number of the information you are seeking.

Abbreviations

NSS - Not Services Separately:

Items which can only be purchased in sets, kit form or service assemblies.

RH - Right Hand

Determined as viewed from behind the vehicle looking forward.

LH - Left Hand

Determined as viewed from behind the vehicle looking forward.

Table of Contents

How to select slack adjusters	Page 2
Steer axle applications	Page 3
Drive axle applications	Page 4
Trailer applications	Page 5
Air Ride Applications	Page 6
Interchange - Haldex to Eaton	Page 7
Interchange - Eaton to Eaton	Page 9

How To Select The Right Eaton Automatic Slack Adjuster Kit

Eaton automatic slack adjusters are designed specifically for steer, drive and trailer applications. Turn to the correct page for your specific application and then...

1. Determine the correct spline:
 - 1 1/4 - 10
 - 1 1/4 - 24
 - 1 1/2 - 10
 - 1 1/2 - 28
 - 1 5/8 - 37
2. Determine the correct arm length:
 - 5
 - 5 1/2
 - 6
 - 6 1/2
 - 7
3. Offsets are available:
 - 5/8
 - 1 1/2
4. Choose the right body angle to avoid interface.

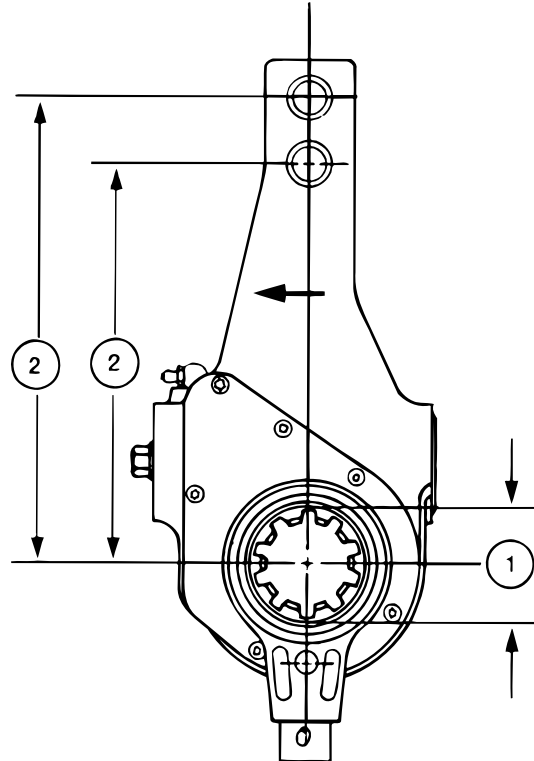

Steer Axle Application

Straight

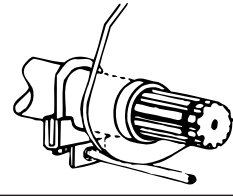
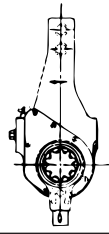
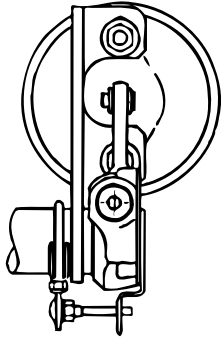

Bracket 815804
815805

Dim "E" 815804 is 2.50"
815805 is 2.00"

Spline	Arm Length	Clevis Size	Kit	Slack Adjuster	Bracket
1 1/4 - 10	5 1/2	5/8 - 1/2	815814	815795-NSS	815804
1 1/4 - 24	5 1/2	5/8 - 1/2	815817	815798-NSS	815805
1 1/2 - 10	5 1/2	5/8 - 1/2	815820	815801-NSS	815804
1 1/2 - 28	5 1/2	5/8 - 1/2	815821	815802-NSS	815804

OFFSET (Clamp Type Bracket)

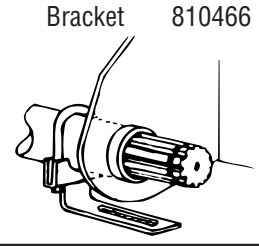
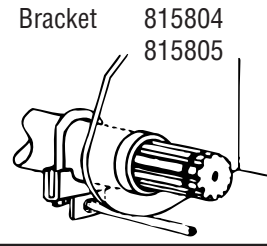
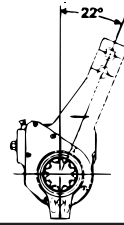
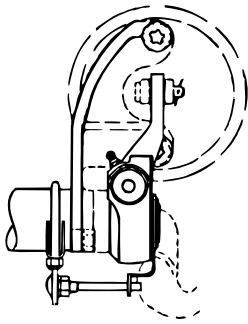

Bracket 815804
815805

Bracket 810466

Spline	Arm Length	Clevis	Offset	Kit	Slack Adjuster	Bracket
1 1/4 - 10	5 1/2	5/8 - 1/2	5/8 RH	815815	815796-NSS	815804
			5/8 LH	815816	815797-NSS	815804
1 1/4 - 24	5 1/2	5/8 - 1/2	5/8 RH	815818	815799-NSS	815805
			5/8 LH	815819	815800-NSS	815805
1 1/2 - 10	5 1/2	1/2	5/8 RH	808156	808119-NSS	810466
			5/8 LH	808157	808120-NSS	810466
1 1/2 - 10	5 1/2	1/2	1 1/2 RH	808165	808128-NSS	810466
			1 1/2 LH	808164	808127-NSS	810466

OFFSET (Bolt-on Type Bracket)

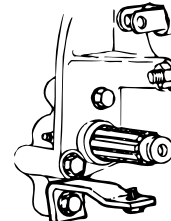
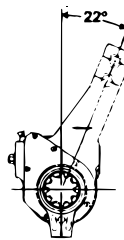
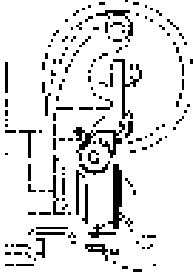

Bracket 808105

Spline	Arm Length	Clevis	Offset	Kit	Slack Adjuster	Bracket
1 1/2 - 28	5 1/2	1/2	1 1/2 RH	808181	808144-NSS	808105
			1 1/2 LH	808182	808145-NSS	808105

Disc.

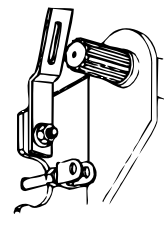
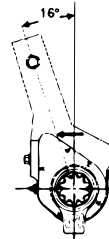
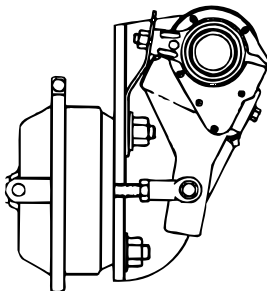

Bracket 815803

Spline	Arm Length	Clevis Size	Kit	Slack Adjuster	Bracket
1 1/2 - 28	5 1/2	1/2	815810	815791-NSS	815803

NSS - Not sold separately . . . order kit

Drive Axle Application

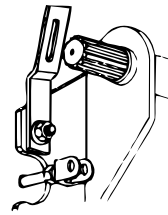
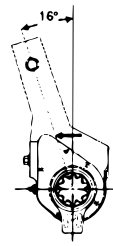
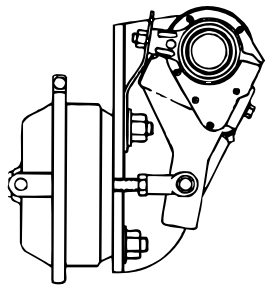

Bracket 815803

Spline	Arm Length	Clevis Size	Kit	Slack Adjuster	Bracket
1 1/2 - 28	5 - 6	5/8 - 1/2	815806	815787-NSS	815803
1 1/2 - 28	5 1/2 - 6 1/2	5/8 - 1/2	815807	815788-NSS	815803
1 1/2 - 10	5 - 6	5/8 - 1/2	815808	815789-NSS	815803
1 1/2 - 10	5 1/2 - 6 1/2	5/8 - 1/2	815809	815790-NSS	815803

Bracket 815804

Bracket 810466

Mack Truck

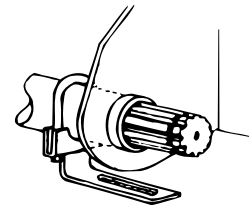
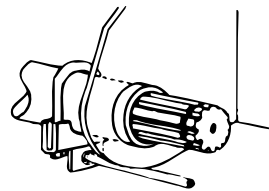
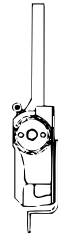
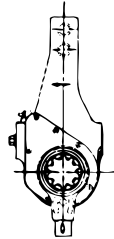
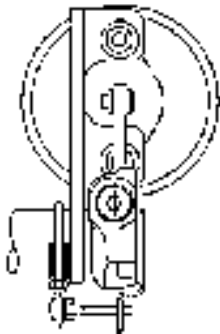

Spline	Arm Length	Clevis Size	Kit	Slack Adjuster	Bracket
1 1/2 - 28	6	1/2	815811	815792-NSS	815804
1 1/2 - 28	5 1/2 - 6 1/2	1/2	815812	815793-NSS	815804
1 1/2 - 10	6	1/2	815813	815794-NSS	815804
1 1/2 - 10	7	1/2	810473	810465-NSS	810466

Mack (With Air Ride Suspension)

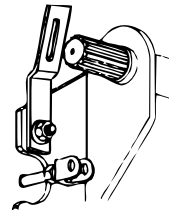
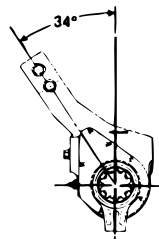
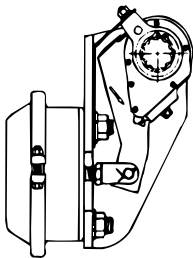

Spline	Arm Length	Clevis Size	Kit	Slack Adjuster	Bracket
1 1/2 - 28	6	1/2	815829	815828-NSS	807567

Disc (Rockwell)

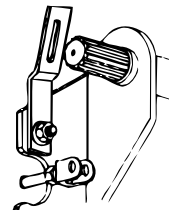
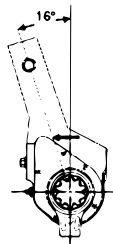
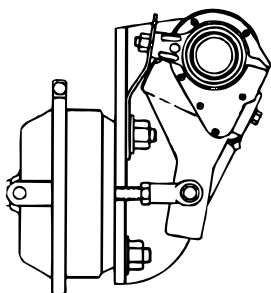

Spline	Arm Length	Clevis Size	Kit	Slack Adjuster	Bracket
1 1/2 - 28	5 1/2	1/2	815810	815791-NSS	815803

NSS - Not sold separately . . . order kit

Trailer Axle Application

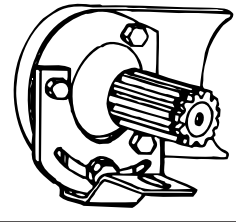
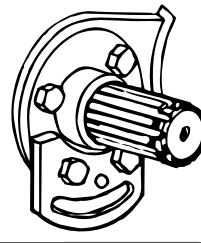
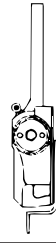
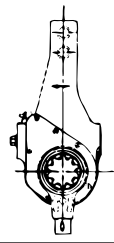

16 1/2" Brake

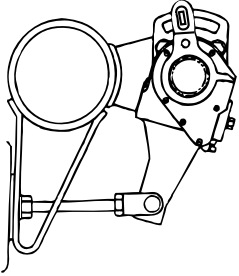

Spline	Arm Length	Clevis Size	Kit	Slack Adjuster	Bracket
1 1/2 - 28	6	1/2	813649	813639-NSS	818152
1 1/2 - 28	5 1/2	1/2	813648	813648-NSS	818152
1 1/2 - 10	6	1/2	813653	818146-NSS	818152
1 1/2 - 10	5 1/2	1/2	813652	818145-NSS	181152
1 5/8 - 37	6	1/2	813651	818144-NSS	818152
1 5/8 - 37	5 1/2	1/2	813650	818143-NSS	818151
1 1/2 - 10**	6	1/2	808354	808375-NSS	808108
1 1/2 - 10	5 - 6	1/2	808150	808114-NSS	813469

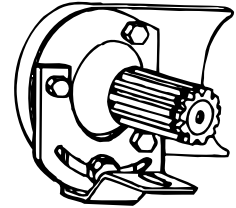
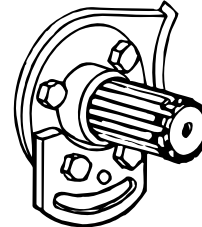
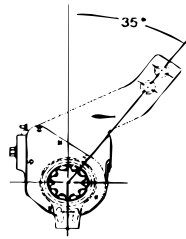

12 1/4" Brake

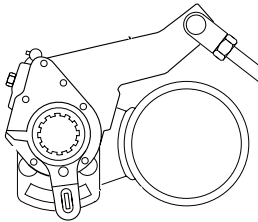

Spline	Arm Length	Clevis Size	Kit	Slack Adjuster	Bracket
1 1/2 - 28	6	1/2	812655	818148-NSS	818152
1 1/2 - 28	5 1/2	1/2	813654	818147-NSS	818152
1 1/2 - 10	6	1/2	813656	818149-NSS	818152
1 5/8 - 37	6	1/2	813657	818150-NSS	181151
1 1/2 - 10**	5 - 6	1/2	808155	808118-NSS	808108
1 1/2 - 10	5 - 6	1/2	808183	808146-NSS	808109

* 813637 contains optional mounting hardware not shown above

**Dana 3 hole bolt on cam support bracket only.

NSS - NOT SOLD SEPERATELY...ORDER KIT

Air Ride Suspension and Reduced Envelope Brake (19 1/2") Applications

Peterbilt (with air ride suspension)

Spline	Arm Length	Clevis Size	Kit	Slack Adjuster	Bracket
1 1/2 - 10	5 1/2	5/8	825468	818552-NSS	818949
1 1/2 - 28	5 1/2	5/8	825366	818553-NSS	818949
1 1/5 - 10	5 - 6	5/8	825702	818990-NSS	818949
1 1/2 - 28	5 - 6	5/8	825703	818991-NSS	818949

Kenworth (with air ride suspension)

Spline	Arm Length	Clevis Size	Kit	Slack Adjuster	Bracket
1 1/2 - 10	5 1/2	5/8	823661	817533-NSS	817550
1 1/2 - 28	5 1/2	5/8	823660	817513-NSS	817550

Reduced Envelope Brake 15" X 8-5/8"

Drive Axles

Spline	Arm Length	Clevis Size	Kit	Slack Adjuster	Bracket
1/2 - 10	5 1/2 - 6 1/2	1/2	808162	808125-NSS	807567

Trailer Axles

Spline	Arm Length	Clevis Size	Kit	Slack Adjuster	Bracket
1 1/2 - 28	6	1/2	813649	818142-NSS	818152

Steer Axles (Rear Mount)

Spline	Arm Length	Clevis Size	Kit	Slack Adjuster	Bracket
1 1/2 - 10	5 1/2 - 6 1/2	1/2	808162	808125-NSS	807567

Steer Axles (All Others)

Spline	Arm Length	Clevis Size	Kit	Slack Adjuster	Bracket
1 1/2 - 10	5 1/2	1/2	314499	809610-NSS	808106

Interchange

Haldex to Eaton

Haldex Number	Current Eaton Kit	Haldex Number	Current Eaton Kit	Haldex Number	Current Eaton Kit	Haldex Number	Current Eaton Kit
400-10001	815814	400-10304	813654	409-10165	808181	409-10310	808384
400-10002	815815	400-10305	813655	409-10168	815821	409-10311	808385
400-10003	815816	400-10306	813656	409-10172	815814	409-10312	815807
400-10004	815817	400-10307	813657	409-10174	815821	409-10313	815809
400-10005	815820	400-10400	808256	409-10176	808182	409-10318	808183
400-10006	808156	400-10401	808257	409-10177	808181	409-10319	815817
400-10007	808157	400-10402	815810	409-10197	815807	409-10325	815816
400-10008	815821	400-10403	808384	409-10211	813656	409-10326	815815
400-10009	808181	400-10404	808385	409-10215	815807	409-10334	815819
400-10010	808182			409-10218	813651	409-10335	815818
400-10011	815807	409-10005	811454	409-10221	815808	409-10343	815806
400-10012	815809	409-10036	810473	409-10222	815821	409-10351	813650
400-10040	815818	409-10051	815813	409-10223	815820	409-10352	813649
400-10041	815819	409-10070	815811	409-10224	815814	409-10360	815806
400-10100	815806	409-10071	815813	409-10228	815821	409-10361	815817
400-10101	815807	409-10085	813652	409-10229	815807	409-10362	815821
400-10102	815808	409-10086	808150	409-10230	813653	409-10363	813654
400-10103	815809	409-10091	815812	409-10230	808354	409-10364	815817
400-10104	815811	409-10093	815806	409-10231	813653	409-10365	813653
400-10105	815813	409-10094	815807	409-10231	808354	409-10365	808354
400-10106	815812	409-10101	815809	409-10232	813652	409-10370	815820
400-10140	815806	409-10108	815820	409-10233	813652	409-10375	810468
400-10141	815807	409-10110	813657	409-10234	813649	409-10376	810469
400-10142	815808	409-10111	813656	409-10235	813649	409-10384	815821
400-10143	815809	409-10111	808155	409-10236	813648	409-10385	815817
400-10144	815811	409-10112	808156	409-10237	811121	409-10386	813648
400-10145	815813	409-10113	808157	409-10238	815809	409-10391	815814
400-10146	815812	409-10114	815816	409-10239	815808	409-10392	813653
400-10200	813649	409-10115	815815	409-10240	815807	409-10392	808354
400-10201	813648	409-10118	810471	409-10241	815806	409-10393	813653
400-10202	813653	409-10119	810472	409-10245	813656	409-10393	808354
400-10203	813652	409-10124	815813	409-10247	813653	409-10394	813652
400-10204	813651	409-10125	815806	409-10249	815816	409-10395	813652
400-10205	813650	409-10126	815807	409-10250	815815	409-10396	813649
400-10206	808354	409-10128	815814	409-10255	809776	409-10397	813649
400-10207	808150	409-10130	815808	409-10257	815820	409-10398	813648
400-10211	813648	409-10131	808256	409-10258	815821	409-10399	813648
400-10212	813649	409-10134	815809	409-10279	813656	409-10404	815829
400-10213	813650	409-10135	815809	409-10282	813654	409-10408	815807
400-10214	813651	409-10146	815811	409-10287	815813	409-10410	815808
400-10215	813652	409-10147	808164	409-10288	815811	409-10416	815807
400-10216	813653	409-10148	808165	409-10293	815809	409-10417	815809
400-10300	813655	409-10149	815806	409-10294	815809	409-10418	813656
400-10301	813656	409-10151	813655	409-10304	808181	409-10430	813648
400-10302	808155	409-10157	808257	409-10305	808182	409-10432	813650
400-10303	813657	409-10164	808182	409-10309	815810	409-10443	815811

Interchange

Haldex to Eaton

Haldex Number	Current Eaton Kit	Haldex Number	Current Eaton Kit	Haldex Number	Current Eaton	Haldex Number	Current Eaton
409-10444	815812	409-10504	815813	427-10217	808104	427-10431	808108
409-10455	815813	409-10505	815813	427-10296	808109	427-10457	808107
409-10465	815817	409-10506	815807	427-10305	808379	427-10466	808381
409-10466	815821	409-10509	815809	427-10314	810467	427-10481	809702
409-10471	813648	409-10529	813649				
				427-10322	813469	427-10497	810466
409-10673	813649	409-10530	815807	427-10401	808106	427-10504	810531
409-10684	813650	409-10532	815807	427-10422	808105	427-10528	808110
409-10674	813651	409-10535	815819	427-10423	1003333	427-10530	813636
409-10685	813652	409-10536	815818	427-10430	807567	427-10534	813637
409-10675	813653	409-10564	815808			427-10538	815804
						427-10539	815805
409-10654	813654	409-10565	815809			427-10543	815803
409-10655	813655	409-10566	815806			427-10554	877550
409-10656	813656	409-10579	815811				
409-10657	813657	409-10580	815812				
409-10495	815814	409-10581	815813				
409-10496	815817	409-10584	815810				
409-10497	815816						
409-10498	815815						
409-10499	815820						
409-10502	815821						

Interchange

Eaton to Eaton

Eaton Part No.	Current Eaton Kit	Eaton Part No.	Current Eaton Kit	Eaton Part No.	Current Eaton Kit	Eaton Part No.	Current Eaton Kit
808112 (S)	815813	808158 (K)	815816	808689 (S)	815816	810731 (S)	815807
808113 (S)	815811	808159 (K)	815815	808690 (S)	815815	810747 (K)	810468
808114 (S)	808150	808160 (K)	815814	808691 (S)	815807	810750 (K)	810469
808115 (S)	815812	808161 (K)	815808	808692 (S)	815807	810815 (S)	815809
808116 (S)	815820	808162 (K)	815809	808693 (S)	815814	810838 (S)	815808
808117 (S)	813657	808163 (K)	815811	808694 (S)	_____	810843 (S)	815807
808118 (S)	813656	808164 (K)	808164	808695 (S)	815814	811007 (S)	811454
808119 (S)	808156	808165 (K)	808165	808746 (S)	815817	811120 (S)	811121
808120 (S)	808157	808166 (K)	815806	809490 (S)	_____	811121 (K)	811121
808121 (S)	815816	808167 (K)	813655	809609 (S)	815820	811336 (S)	815821
808122 (S)	815815	808168 (K)	815821	809610 (S)	815820	811454 (K)	811454
808123 (S)	815814	808169 (K)	815807	809611 (S)	815821	812351 (S)	815807
808124 (S)	815808	808170 (K)	813651	809612 (S)	815821	812642 (S)	812644
808125 (S)	815809	808171 (K)	815807	809613 (S)	815820	812643 (S)	812645
808126 (S)	815811	808172 (K)	813653	809614 (S)	_____	812926 (S)	815819
808127 (S)	808164	808173 (K)	813652	809615 (S)	_____	812927 (S)	815818
808128 (S)	808165	808174 (K)	813649	809616 (S)	813706	813246 (S)	813248
808129 (S)	815806	808175 (K)	813648	809617 (S)	824156	813247 (S)	813249
808130 (S)	813655	808176 (K)	815809	809618 (S)	810468	813260 (S)	_____
808131 (S)	815821	808177 (K)	815808	809619 (S)	810469	813500 (S)	813501
808132 (S)	815807	808178 (K)	815807	809754 (K)	815814	813638 (S)	813648
808133 (S)	813651	808179 (K)	815806	809774 (S)	815814	813639 (S)	813649
808134 (S)	815807	808180 (K)	815809	809775 (S)	809776	813640 (S)	813650
808135 (S)	813653	808181 (K)	808181	809776 (K)	809776	813641 (S)	813651
808136 (S)	813652	808182 (K)	808182	810047 (S)	815807	813642 (S)	813652
808137 (S)	813649	808183 (K)	808183	810180 (K)	815809	813643 (S)	813653
808138 (S)	813648	808184 (K)	815817	810338 (S)	_____	813644 (S)	813654
808139 (S)	815809	808254 (S)	808256	810339 (S)	_____	813645 (S)	813655
808140 (S)	815808	808255 (S)	808257	810358 (S)	815817	813646 (S)	813656
808141 (S)	815807	808256 (K)	808256	810359 (K)	815817	813647 (S)	813657
808142 (S)	815806	808257 (K)	808257	810463 (S)	810471	813704 (S)	815108
808143 (S)	815809	808354 (K)	808354	810464 (S)	810472	813705 (S)	815109
808144 (S)	808181	808375 (S)	813653	810465 (S)	810473	813844 (S)	813846
808145 (S)	808182	808376 (S)	815810	810468 (K)	810468	813845 (S)	813847
808146 (S)	808183	808377 (S)	808384	810469 (K)	810469	814696 (S)	_____
808147 (S)	815817	808378 (S)	808385	810471 (K)	810471	814697 (S)	_____
808148 (K)	815813	808382 (K)	813653	810472 (K)	810472	815106 (S)	823636
808149 (K)	815811	808383 (K)	815810	810473 (K)	810473	815107 (S)	823637
808150 (K)	808150	808384 (K)	808384	810600 (S)	815812	815410 (S)	825502
808151 (K)	815812	808385 (K)	808385	810601 (S)	815806	815411 (S)	825503
808152 (K)	815820	808679 (S)	815809	810602 (S)	815807	815594 (S)	823912
808153 (K)	813657	808684 (S)	813652	810603 (S)	815806	815595 (S)	823913
808154 (K)	813656	808685 (S)	815806	810686 (S)	813650		
808155 (K)	808155	808686 (S)	_____	810728 (S)	815809		
808156 (K)	808156	808687 (S)	814505	810729 (S)	_____		
808157 (K)	808157	808688 (S)	815809	810730 (S)	_____		

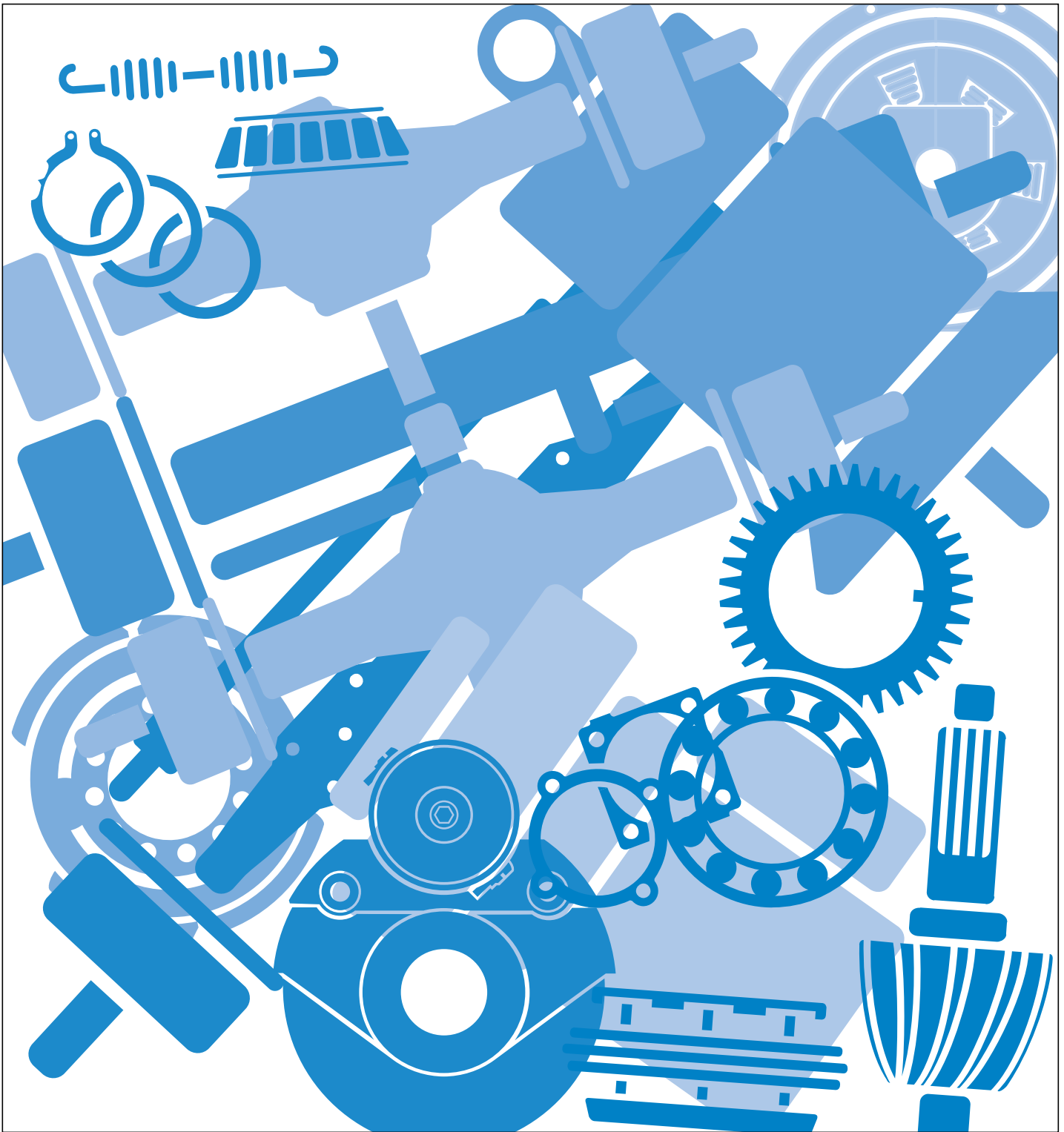

Copyright Eaton and Dana Corporation, 2002. EATON AND DANA CORPORATION hereby grants its customers, vendors, or distributors permission to freely copy, reproduce and/or distribute this document in printed format. THIS INFORMATION IS NOT INTENDED FOR SALE OR RE-SALE, AND THIS NOTICE MUST REMAIN ON ALL COPIES.



National Institute for
**AUTOMOTIVE
SERVICE
EXCELLENCE**

Roadranger®

MORE TIME ON THE ROAD

The Roadranger® System is an unbeatable combination of the best products from Eaton and Dana – partnering to provide you the most advanced, most trouble-free drivetrain in the industry. And it's backed by the Roadrangers – the most experienced, most expert, most accessible drivetrain consultants in the business.

For spec'ing or service assistance, call 1-800-826-HELP (4357) 24 hours a day, 7 days a week, (Mexico: 001-800-826-HELP (4357)) for more time on the road. Or visit our web site at www.roadranger.com.



EAT•N

One Great Drivetrain from Two Great Companies

BRIP-0075
12/95 PDF
Printed in USA