

Bendix® Vision Systems

Head Up Display, Raytheon 4000B ProtectIR Camera, IR Camera, Flat Panel Display and Side/Rear Camera



OE Pc. No.	Service Pc. No.	Page No.	OE Pc. No.	Service Pc. No.	Page No.	OE Pc. No.	Service Pc. No.	Page No.
	801150	19-B-1		801501	19-A-4	5010524	5010524	19-C-2
	801151	19-D-2		801502	19-A-4	5011098	801427	19-D-1
	801152	19-D-2		801503	19-A-5	5011270	801426	19-D-1
	801154	19-C-1		801504	19-A-6	5011271	801425	19-D-1
	801155	19-D-2		801505	19-A-6	5011558	5011558	19-D-3
	801156	19-B-2		801508	19-B-3	5011712	801486	19-C-3
	801156	19-D-1		801509	19-B-3	5011715	801487	19-D-1
	801157	19-D-1		801510	19-B-3	5011717	801488	19-D-1
	801157	19-D-2		801511	19-B-3	5011719	801489	19-B-2
	801409	19-C-3		801512	19-B-3	5011720	801490	19-C-1
	801411	19-D-3		801513	19-B-3	5011761	801491	19-C-3
	801414	19-D-3		801514	19-B-3	5011763	801492	19-C-3
	801416	19-D-3		801515	19-B-3	5011765	801493	19-C-3
	801418	19-B-4		801516	19-B-3	5011767	801494	19-C-3
	801422	19-D-2	3264500	801508	19-B-3	5011788	801495	19-B-4
	801423	19-D-2	3264501	801509	19-B-3	5011942	801416	19-D-3
	801423	19-B-4	3264502	801510	19-B-3	5011943	801414	19-D-3
	801424	19-D-2	3264503	801511	19-B-3	5011944	801409	19-C-3
	801425	19-D-1	3264504	801512	19-B-3	5011945	801411	19-D-3
	801426	19-D-1	3264506	801513	19-B-3	5011947	801442	19-D-3
	801427	19-D-1	3264507	801514	19-B-3	5011948	801418	19-B-4
	801428	19-D-1	3264508	801515	19-B-3	5011952	801422	19-D-2
	801429	19-D-1	3264509	801516	19-B-3	5011953	801423	19-B-4
	801430	19-D-3	5008214	801150	19-B-2	5011954	801424	19-D-2
	801431	19-D-3	5008776	5008776	19-B-1	5012039	801431	19-D-3
	801440	19-D-3	5009616	5009616	19-C-2	5012050	801440	19-D-3
	801441	19-D-3	5010078	5010078	19-B-1	5012052	801446	19-D-3
	801442	19-D-3	5010079	5010079	19-B-1	5012053	801448	19-D-2
	801446	19-D-3	5010081	5010081	19-C-2	5012054	801441	19-D-3
	801448	19-D-2	5010082	5010082	19-C-2	5012077	801496	19-D-1
	801469	19-B-2	5010083	5010083	19-D-1	5012078	801497	19-C-2
	801486	19-C-3	5010086	5010086	19-A-3	5012079	801469	19-B-2
	801487	19-D-1	5010187	5010187	19-B-1	5012080	801498	19-A-5
	801488	19-D-1	5010189	5010189	19-C-2	5012081	801499	19-A-4
	801489	19-B-2	5010190	5010190	19-C-2	5012083	801500	19-A-3
	801490	19-C-1	5010192	5010192	19-B-1	5012085	801501	19-A-4
	801491	19-C-3	5010193	5010193	19-B-1	5012088	801502	19-A-4
	801492	19-C-3	5010210	801154	19-C-1	5012090	801503	19-A-5
	801493	19-C-3	5010246	801156	19-B-2	5012092	801504	19-A-6
	801494	19-C-3	5010246	801156	19-D-1	5012093	801505	19-A-6
	801495	19-B-4	5010247	5010247	19-C-2	5012129	801428	19-D-1
	801496	19-D-1	5010249	5010249	19-C-2	5012130	801429	19-D-1
	801497	19-C-2	5010259	801151	19-D-2	5012134	801430	19-D-3
	801498	19-A-5	5010260	801157	19-D-2			
	801499	19-A-4	5010263	801155	19-D-2			
	801500	19-A-3	5010441	801152	19-D-2			

Vision System Kit Configurations:

Service Piece No.	Camera(s)	Display(s)
5010086	IR	HUD
801498	Raytheon, Side/Rear	Flat Panel
801499	Raytheon	Flat Panel
801500	IR	Flat Panel
801501	IR	Flat Panel, HUD
801502	Side/Rear	Flat Panel
801503	IR, Side/Rear	Flat Panel
801504	Raytheon	Flat Panel, HUD
801505	Raytheon, Side/Rear	Flat Panel, HUD

IR Camera & Head Up Display System Retrofit Kit, Service Piece No. 5010086 consists of the following:

Description	Qty.	Service Piece No.	Page No.
IR Camera	1	–	19-B-1
HUD Display	1	–	19-C-1
Camera Bracket Kit	1	5010078	19-B-1
CB Mounting Kit (HUD)	1	5010081	19-C-2
Friction Mounting Kit (HUD)	1	5010082	19-C-2
Harness Kit	1	5010083	19-D-3
Aiming Adjuster Tool	1	–	–
XVision Retrofit Video	1	BW2219	–

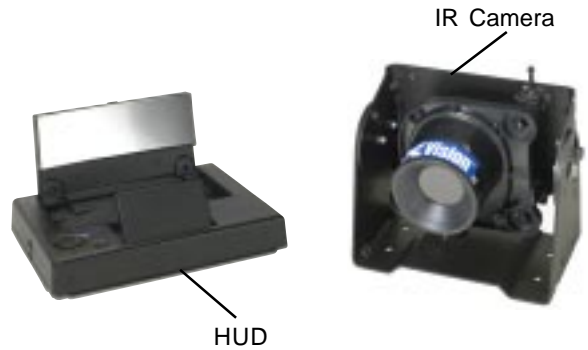

IR Camera & Flat Panel Display Retrofit Kit, Piece No. 801500 consists of the following:

Description	Qty.	Service Piece No.	Page No.
6.8 Flat Panel Display Kit	1	801486	19-C-3
NVVC Kit	1	801488	19-D-1
IR Camera Kit	1	801489	19-B-2
Fixed Mounting Bracket Kit	1	801491	19-C-3
Video Output Extension	1	801442	19-D-3
Vehicle Power Harness	1	801440	19-D-3
Vehicle Power Harness	1	801430	19-D-3
Aiming Adjuster Tool	1	–	–

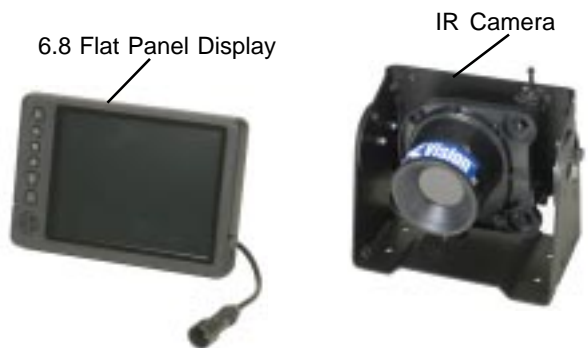

Raytheon 4000B ProtectIR Camera & Flat Panel Display Retrofit Kit, Piece No. 801499 consists of the following:

Description	Qty.	Service Piece No.	Page No.
6.8 Flat Panel Display Kit	1	801486	19-C-3
Fixed Mounting Bracket Kit	1	801491	19-C-3
Jumper Harness 6.8	1	801431	19-D-3
Vehicle Power Harness	1	801440	19-D-3
Raytheon 4000B ProtectIR Camera Kit	1	801508	19-B-3
Connector Adapter	1	5011558	19-D-3



Side/Rear Vision Camera & Flat Panel Display Retrofit Kit, Piece No. 801502 consists of the following:

Description	Qty.	Service Piece No.	Page No.
6.8 Flat Panel Display Kit	1	801486	19-C-3
Fixed Mounting Bracket Kit	1	801491	19-C-3
Side/Rear Vision Camera Kit	1	801495	19-B-4
Vehicle Power Harness	1	801440	19-D-3

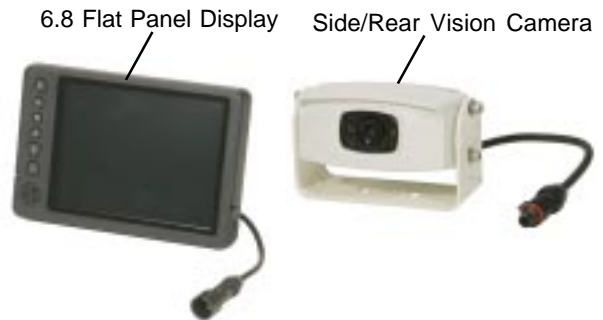

IR Camera, Head Up Display & Flat Panel Display Retrofit Kit, Piece No. 801501 consists of the following:

Description	Qty.	Service Piece No.	Page No.
6.8 Flat Panel Display Kit	1	801486	19-C-3
IR Camera Kit	1	801489	19-B-2
HUD Cab Mounting Kit	1	801490	19-C-1
Fixed Mounting Bracket Kit	1	801491	19-C-3
Jumper Harness 6.8	1	801431	19-D-3
Vehicle Power Harness	1	801440	19-D-3
Video Extension Harness	1	801446	19-D-3
Aiming Adjuster Tool	1	-	-



IR Camera, Side/Rear Vision Camera & Flat Panel Display Retrofit Kit, Piece No. 801503 consists of the following:

Description	Qty.	Service Piece No.	Page No.
6.8 Flat Panel Display Kit	1	801486	19-C-3
NVVC Kit	1	801488	19-D-1
IR Camera Kit	1	801489	19-B-2
Fixed Mounting Bracket Kit	1	801491	19-C-3
Side/Rear Vision Camera Kit	1	801495	19-B-4
Video Output Extension	1	801442	19-D-3
Vehicle Power Harness	1	801440	19-D-3
Vehicle Power Harness	1	801430	19-D-3
Aiming Adjuster Tool	1	-	-



Raytheon 4000B ProtectIR Camera, Side/Rear Vision Camera & Flat Panel Display Retrofit Kit, Piece No. 801498 consists of the following:

Description	Qty.	Service Piece No.	Page No.
6.8 Flat Panel Display Kit	1	801486	19-C-3
Fixed Mounting Bracket Kit	1	801491	19-C-3
Side/Rear Vision Camera Kit	1	801495	19-B-4
Jumper Harness 6.8	1	801431	19-D-3
Vehicle Power Harness	1	801440	19-D-3
Raytheon 4000B ProtectIR Camera Kit	1	801508	19-B-3
Connector Adapter	1	5011558	19-D-3



Raytheon 4000B ProtectIR Camera, Head Up Display & Flat Panel Display Retrofit Kit, Piece No. 801504 consists of the following:

Description	Qty.	Service Piece No.	Page No.
6.8 Flat Panel Display Kit	1	801486	19-C-3
HUD Cab Mounting Kit	1	801490	19-C-1
Fixed Mounting Bracket Kit	1	801491	19-C-3
Jumper Harness 6.8	1	801431	19-D-3
Vehicle Power Harness	1	801440	19-D-3
IR Video Harness	1	801448	19-D-2
Raytheon 4000B ProtectIR Camera Kit	1	801508	19-B-3
Connector Adapter	1	5011558	19-D-3



Raytheon 4000B ProtectIR Camera, Side/Rear Vision Camera, Head Up Display & Flat Panel Display Retrofit Kit, Piece No. 801505 consists of the following:

Description	Qty.	Service Piece No.	Page No.
6.8 Flat Panel Display Kit	1	801486	19-C-3
HUD Cab Mounting Kit	1	801490	19-C-1
Fixed Mounting Bracket Kit	1	801491	19-C-3
Side/Rear Vision Camera Kit	1	801495	19-B-4
Jumper Harness 6.8	1	801431	19-D-3
Vehicle Power Harness	1	801440	19-D-3
IR Video Harness	1	801448	19-D-2
Power Pigtail Harness	1	801441	19-D-3
Raytheon 4000B ProtectIR Camera Kit	1	801508	19-B-3
Connector Adapter	1	5011558	19-D-3



CAMERA, CAMERA BRACKET KIT AND REPLACEMENT PARTS

IR CAMERA

CATALOG
19-B-1

The following tables include information about each of the parts/kits that are serviceable and can be ordered through Bendix®. If a part is not followed by its piece number, it can not be ordered individually, but only as a component of a larger kit.

WEIGHT – 2.2 LBS.
DEVICE CODE IS 5162

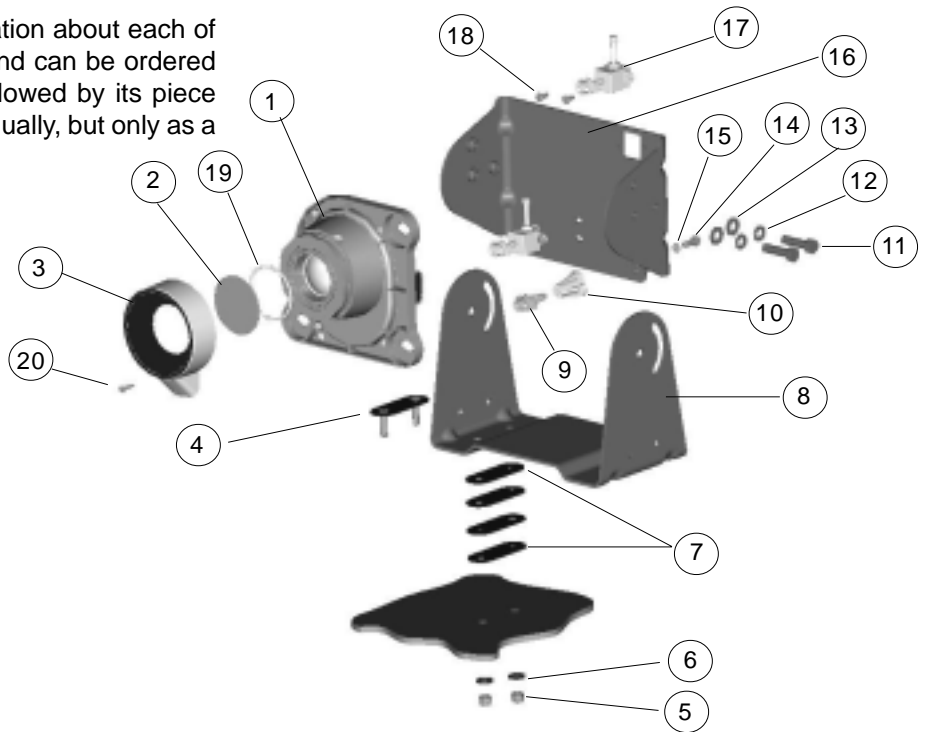

IR Camera, Service Piece No. 801150		
Item No.	Description	Qty.
1	IR Camera	1

Camera Bracket Kit, Service Piece No. 5010078			
Item No.	Description	Service Piece No.	Qty.
13	5/16 Lockwasher	–	4
12	5/16 Washer	–	4
11	5/16 Cap Screw	–	4
NS	Cable Tie	–	1
4-8	Mounting Bracket Kit	5010187	1
9-10, 14-18	Bracket with Aiming Adjusters	–	1

Window Replacement Kit, Service Piece No. 5010192			
Item No.	Description	Service Piece No.	Qty.
2	Camera Window	5008776	1
19	O-ring	–	1
20	Nylon Rivet	–	1
NS	Cleaning Brush	–	1

Mounting Bracket Kit, Service Piece No. 5010187		
Item No.	Description	Qty.
6	1/4 Washer	4
5	Locknut Prevailing Torque	4
8	Mounting Bracket Complete	1
4	Stud Plate Complete (1" & 1 1/4")	2 each
7	Leveling Shim	8
NS	Sealant	1

Aiming Adjuster Replacement Kit, Service Piece No. 5010079		
Item No.	Description	Qty.
18	#8 Hex Torx Screws	4
17	Aiming Assembly	2
9	Standoff Pivot Assembly	1
10	Standoff Base	1
14	Plastite Screw	1
15	#10 Lock Washer	1

Heater Replacement Kit, Service Piece No. 5010193		
Item No.	Description	Qty.
3	Window Heater	1
20	Nylon Rivet	1

NS = Item Not Shown



IR Camera Kit Service Piece No. 801489			
Description	Service Piece No.	Qty.	Page No.
Camera Std.	801150	1	
Camera Bracket Kit	5010078	1	19-B-1
IR Camera Harness	801156	1	
Camera Jumper Harness	801152	1	19-D-1

IR Camera Cover Kit Service Piece No. 801469	
Description	Qty.
Camera Cover	1
Standoff	2
Socket Head Screw	4
Nylon Washer	6



Camera Cover

The Raytheon 4000B ProtectIR camera is designed for stationary search & surveillance operations. It combines infrared camera technology with vertical and horizontal scanning, using a handcontroller joystick.

The following tables include information about each of the parts/kits that are serviceable and can be ordered through Bendix®. If a part is not followed by its piece number, it can not be ordered individually, but only as a component of a larger kit.

DEVICE CODE IS 5162



Raytheon 4000B ProtectIR Camera Kit, Service Piece No. 801508 consists of the following:

Description	Qty.	Service Piece No.
Raytheon 4000B ProtectIR Camera	1	801509
Mounting Ring	1	801511
Hand Controller	1	801512
Electronic Module	1	801510
System Harness	1	801513
Power Harness	1	801514
Video Harness	1	801515
Hand Controller Harness	1	801516

The side/rear vision camera reduces blind spots when backing up or changing lanes. This LED-assisted camera provides superior low-light performance. An embedded microphone supplies audio to the flat panel display speaker.

WEIGHT – 1 LB.
DEVICE CODE IS 5162



Side/Rear Vision Camera & Harness Kit Service Piece No. 801495		
Description	Service Piece No.	Qty.
Side/Rear Vision Camera	801418	1
Camera Extension Harness	801423	1
Harness Cover	–	1
Mounting Hardware	–	1

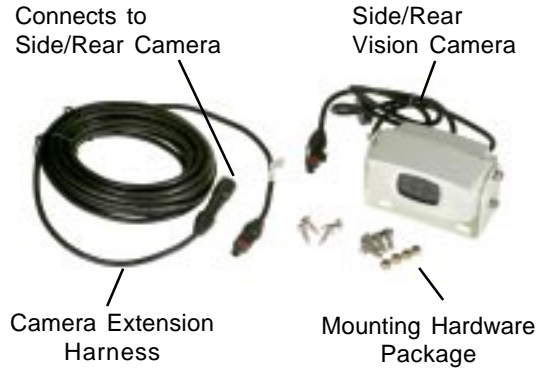

The Head Up Display (HUD), with dimming capability, is ideally suited for nighttime driving. It receives signals from an infrared camera and projects the images onto a screen. The HUD can be mounted either to the vehicle's dash or beneath the headliner. When not in use, the notebook size HUD folds flat.



DEVICE CODE IS 5161

Video Display	
Description	Service Piece No.
Video Display	801154

HUD with CB Mounting Kit Service Piece No. 801490			
Description	Service Piece No.	Qty.	Page No.
Mounting Kit	5010081	1	19-C-2
Video Display	801154	1	
HUD Harness	801151	1	19-D-2
Vehicle Harness Kit	801487	1	19-D-3

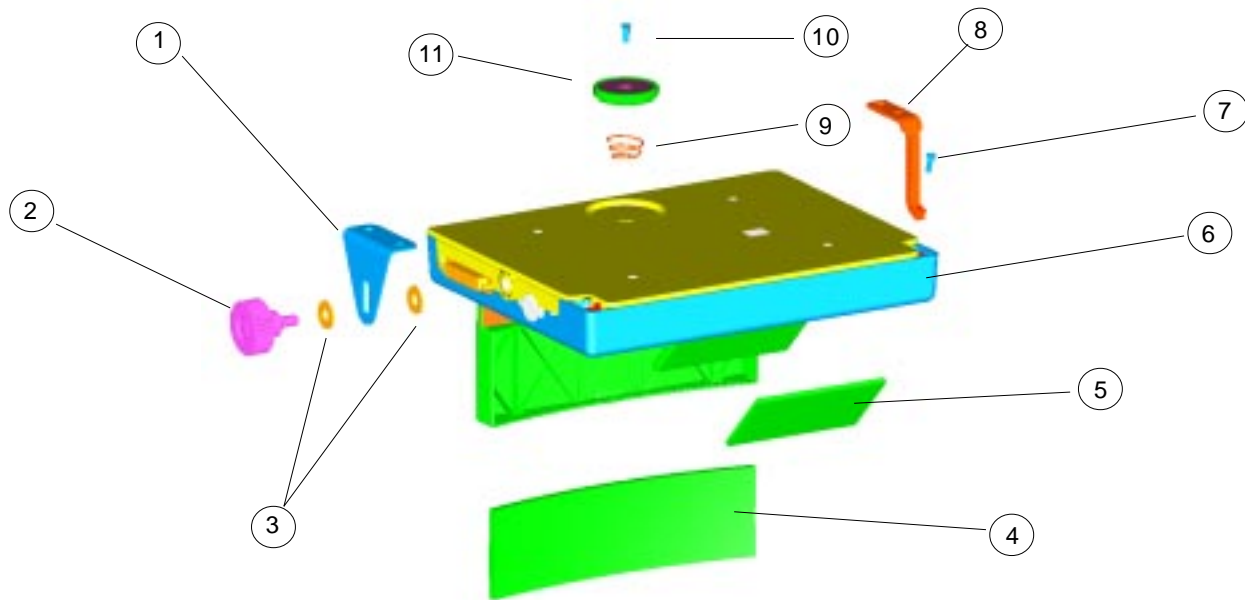

The following tables include information about each of the parts/kits that are serviceable and can be ordered through Bendix®. If a part is not followed by its piece number, it can not be ordered individually, but only as a component of a larger kit.

HUD Overhead Mounting Kit, Service Piece No. 801497			
Item No.	Description	Service Piece No.	Qty.
7-11	Friction Hinge Mounting Kit	5010082	1
NS	HUD Harness (page 19-D-2)	801155	1

Fold Mirror Replacement Kit, Service Piece No. 5010189		
Item No.	Description	Qty.
5	Replacement Mirror	1

Combiner Mirror Replacement Kit, Service Piece No. 5010190		
Item No.	Description	Qty.
4	Replacement Combiner	1

CB Mounting Kit, Service Piece No. 5010081			
Item No.	Description	Service Piece No.	Qty.
1	Mounting Bracket	5009616	2
2-3	Knob Kit	5010247	1
NS	Plastite Screw (1/2")	-	4

Knob Kit, Service Piece No. 5010247		
Item No.	Description	Qty.
3	1/4 Flat Washer	4
2	1/4-20 Thread Knob	2

Friction Hinge Mounting Kit, Service Piece No. 5010082			
Item No.	Description	Service Piece No.	Qty.
7	#4 Threadroll Screw	-	2
8	Hinge Support	-	2
NS	Screw and Shim Kit	5010249	1
9-11	Magnet Kit	5010524	1

Screw and Shim Kit, Service Piece No. 5010249		
Item No.	Description	Qty.
NS	Spacer Block	12
NS	#10-14 Plastite Screw (1/2")	4
NS	#10-14 Plastite Screw (3/4")	4
NS	#10-14 Plastite Screw (1")	4

Magnet Kit, Service Piece No. 5010524		
Item No.	Description	Qty.
11	Magnet	1
NS	Flatwasher	1
10	#6-19 Plastite Screw	1
NS	Striker Complete	1
NS	#8-16 Plastite Screw	1
NS	Flat Head Screw (1/2")	1
NS	Flat Head Screw (3/4")	1
NS	Flat Head Screw (1")	1
9	Conical Spring	1

NS = Item Not Shown

FLAT PANEL DISPLAY

DISPLAYS

CATALOG 19-C-3

The flat panel display is designed as a multipurpose display. The flat panel display may be used with any combination of the fixed IR camera, Raytheon 4000B ProtectIR camera, or the side/rear vision camera.



DEVICE CODE IS 5161

6.8" Flat Panel Display Installation Kit Service Piece No. 801486			
Description	Service Piece No.	Qty.	Page
Power Harness 6.8	801416	1	19-D-3
Junction Box 6.8	801414	1	19-D-3
Flat Panel Display 6.8	801409	1	19-C-3
Display Harness 6.8	801411	1	19-D-3

MOUNTING KITS

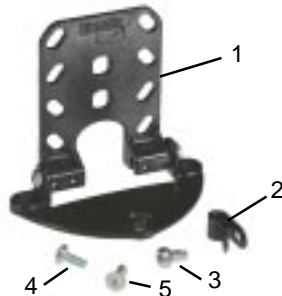

Fixed Mounting Bracket Kit Service Piece No. 801491		
Item No.	Description	Qty.
1	Mounting Bracket	1
2	Tubing Clamp	4
3	Pan Head Threadroll Screw (#8-32)	1
4	Pan Head Plastite Screw (#8-16)	4
5	Flat Head Plastite Screw (#8-16)	3

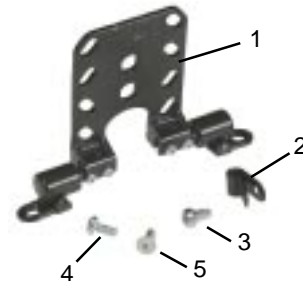

Fold Back Mounting Bracket Kit Service Piece No. 801492		
Item No.	Description	Qty.
1	Mounting Bracket	1
2	Tubing Clamp	4
3	Pan Head Threadroll Screw (#8-32)	1
4	Pan Head Plastite Screw (#8-16)	4
5	Flat Head Plastite Screw (#8-16)	2



Fold Forward Mounting Bracket Kit Service Piece No. 801493		
Item No.	Description	Qty.
1	Mounting Bracket	1
2	Tubing Clamp	4
3	Pan Head Threadroll Screw (#8-32)	1
4	Pan Head Plastite Screw (#8-16)	4
5	Flat Head Plastite Screw (#8-16)	2

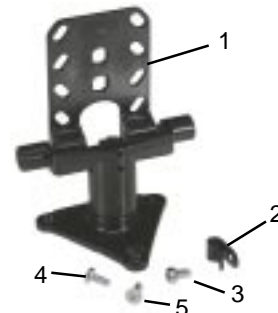

Pivot Mounting Bracket Kit Service Piece No. 801494		
Item No.	Description	Qty.
1	Mounting Bracket	1
2	Tubing Clamp	4
3	Pan Head Threadroll Screw (#8-32)	1
4	Pan Head Plastite Screw (#8-16)	4
5	Flat Head Plastite Screw (#8-16)	3

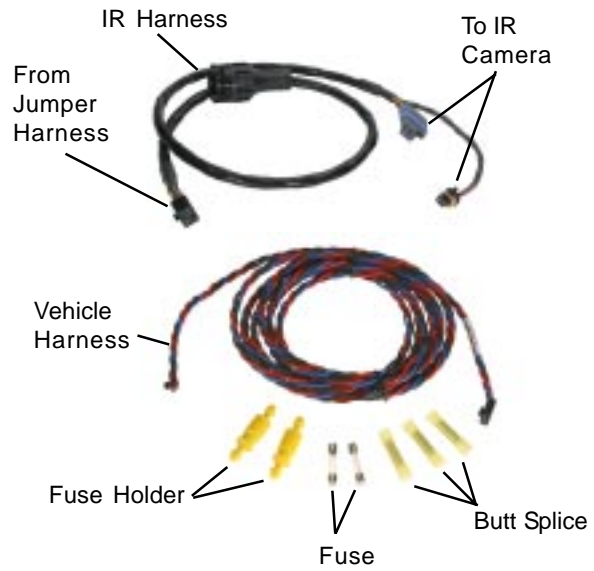
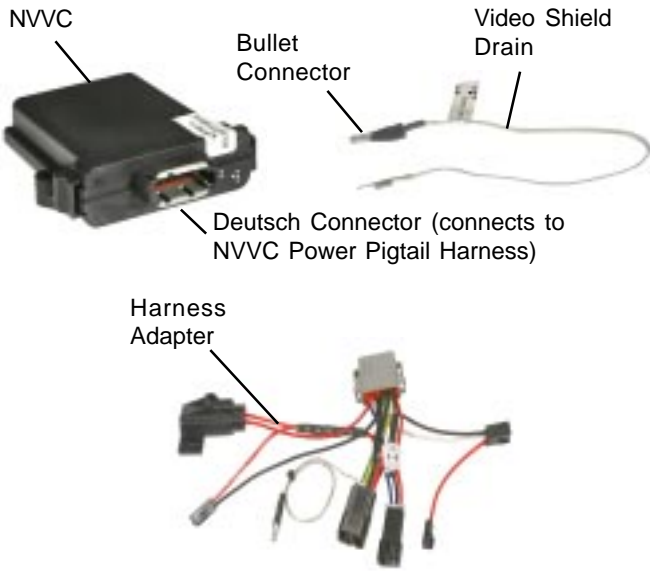

NVVC Kit, Service Piece No. 801488		
Description	Service Piece No.	Qty.
NVVC	801427	1
Harness Adapter	801428	1
Video Shield Drain	801429	1

IR Harness Kit, Service Piece No. 5010083			
Description	Service Piece No.	Page No.	Qty.
IR Camera Harness	801156		1
HUD Harness Rear	801151	19-D-2	1
Vehicle Harness	801157	19-D-2	1
HUD Harness Front	801155	19-D-2	1
Camera Jumper Harness	801152	19-D-2	1
Fuse Holder			2
Butt Splice			3
Fuse 1 Amp			1
Fuse 3 Amp			1

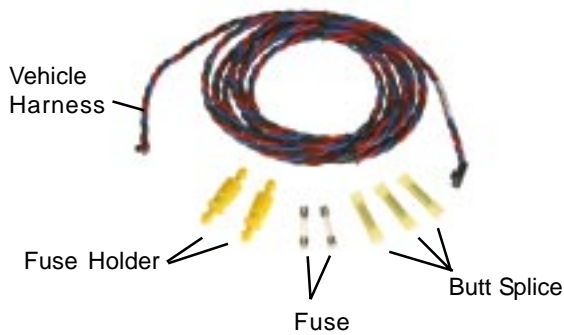

Vehicle Harness Kit Service Piece No. 801487		
Description	Service Piece No.	Qty.
Vehicle Harness	801157	1
Fuse Holder		2
Butt Splice		3
Fuse 1 Amp		1
Fuse 3 Amp		1

Video Switch Kit Service Piece No. 801496		
Description	Service Piece No.	Qty.
Power Harness	801426	1
Camera Switcher	801425	1

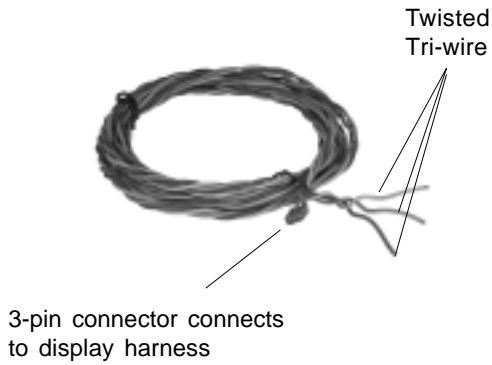

Vehicle Harness Service Piece No. 801157	
Description	Qty.
Vehicle Harness	1

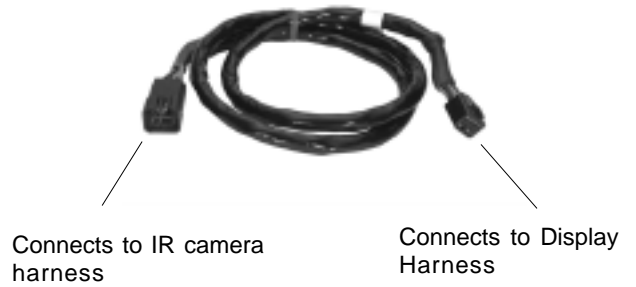

Jumper Harness Service Piece No. 801152	
Description	Qty.
Jumper Harness	1

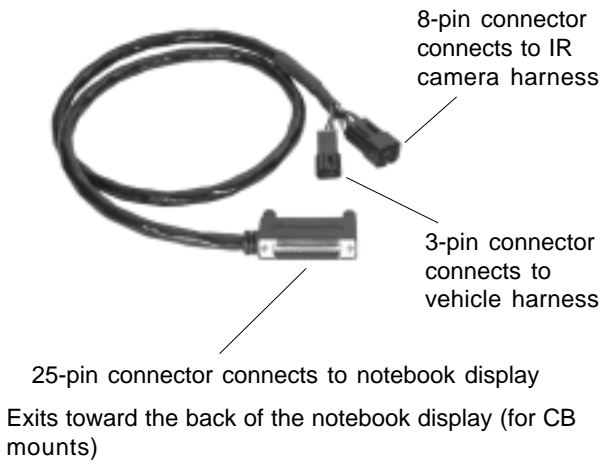

Display Harness Service Piece No. 801151	
Description	Qty.
Vehicle Harness	1

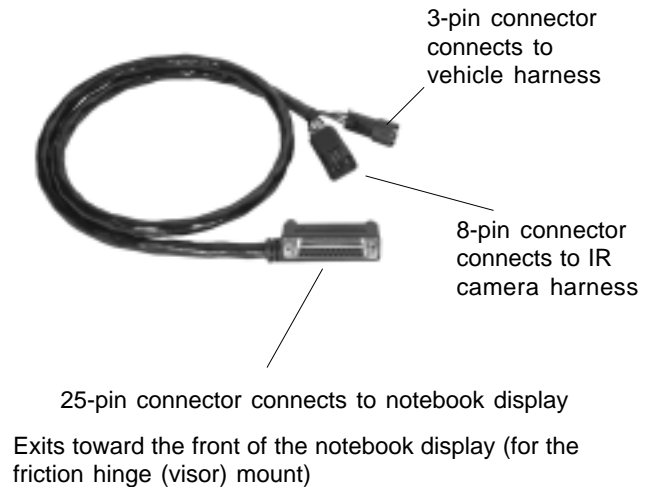

Display Harness Service Piece No. 801155	
Description	Qty.
Vehicle Harness	1



Camera Harness Extension		
Description	Qty.	Service Piece No.
Camera Harness Extension - 25'	1	801422
Camera Harness Extension - 50'	1	801423
Camera Harness Extension - 75'	1	801424



Pan & Tilt Video HUD Harness Service Piece No. 801448	
Description	Qty.
Pan & Tilt Video HUD Harness	1

HARNESSES AND MISCELLANEOUS COMPONENTS



Vehicle Power Harness Service Piece No. 801430	
Description	Qty.
Vehicle Power Harness	1



Vehicle Power Harness Service Piece No. 801440	
Description	Qty.
Vehicle Power Harness	1



Jumper Harness 6.8 Service Piece No. 801431	
Description	Qty.
Jumper Harness 6.8	1



Power Pigtail Harness Service Piece No. 801441	
Description	Qty.
Power Pigtail Harness	1



Video Output Extension Service Piece No. 801442	
Description	Qty.
Video Output Extension	1



Video Extension Harness Service Piece No. 801446	
Description	Qty.
Video Extension Harness	1



Junction Box, Service Piece No. 801414	
Description	Qty.
NVH-1 Junction Box 6.8	1



Power Harness 6.8 Service Piece No. 801416	
Description	Qty.
Power Harness 6.8	1



Connector Adapter Service Piece No. 5011558	
Description	Qty.
Connector Adapter	1



Display Harness – Flat Panel Service Piece No. 801411	
Description	Qty.
Display Harness	1